

**Notification of the National Broadcasting and Telecommunications Commission
on Licensing Criteria and Procedures for Radio or Television**

Broadcasting Network Services

B.E. 2555 (2012)

Whereas it is expedient to prescribe criteria and procedures for granting a license to the radio or television broadcasting business for the network provider in accordance with the Notification of the National Broadcasting and Telecommunications Commission on Characteristics and Categories of Radio and Television Broadcasting Business and to inform the person who intends to operate such business in advance of requirements on qualifications of applicants, licensing application procedures, criteria for granting a license, relevant documents or information required for licensing, licensing approval procedures, timeframe for considering and approving an application, and scope of permit to operate the business, including any other necessary conditions for the radio or television broadcasting network service provisions;

By virtue of Section 27 paragraph one (6) and (24) and Section 41 of the Act on Organization to Assign Radio Frequency and to Regulate the Broadcasting and Telecommunications Services B.E. 2553 (2010) being an Act which contains certain provisions in relation to the restriction of rights and liberties of persons, in respect of which Section 29, in conjunction with Section 35, Section 36, Section 41, Section 43, Section 45, Section 46 and Section 47 of the Constitution of the Kingdom of Thailand so permit by virtue of law, and Section 7 and Section 16 of the Broadcasting Business Act B.E. 2551 (2008) being an Act which contains certain provisions in relation to the restriction of rights and liberties of persons, in respect of which Section 29 in conjunction with Section 35, Section 36, Section 41, Section 43, Section 45, Section 46 and Section 47 of the Constitution of the Kingdom of Thailand so permit by virtue of law, the National Broadcasting and Telecommunications Commission hereby prescribes licensing criteria and procedures for radio or television business which provides radio or television network services as follows:

Clause 1 This Notification shall be called “Notification of the National Broadcasting and Telecommunications Commission on Licensing Criteria and Procedures for Radio or Television Broadcasting Network Services B.E. 2555 (2012).”

Clause 2 This Notification shall come into force as from the day following the date of its publication in the Government Gazette.

Clause 3 Any notifications, regulations, rules or any other ordinances having been prescribed in, or contrary or contradictory to this Notification shall be superseded by this Notification.

Unofficial Translation

Clause 4 In this Notification:

“Radio or television broadcasting network services” means a provision of interconnection system of the set of transmitters or audio or visual broadcasting equipment being used for the broadcasting of public information or programs from a station to receiver either by means of any wire, radio frequency, optical, electromagnetic waves or any other means;

“Radio or television broadcasting services” means a radio or television business for transmission of public information or programs to receiver that is able to receive the signal and view or listen to the content through any of radio frequency, wire, optical, electromagnetic waves, or other means, or a combination thereof, or the provision of similar services prescribed by the Commission as radio or television broadcasting services;

“Radio or television broadcasting facility” means infrastructure or facilities for the radio or television broadcasting services such as land, building, premise, pole, cable, antenna, pipe or any other objects as prescribed by the Commission;

“Applicant” means a person applying for a license to operate radio or television broadcasting business under this Notification;

“Revenue” means income received from the provision of services of a licensee, subscription fees, advertisements either directly or indirectly, or other income that is related to the services provided by the licensee;

“Commission” means the Broadcasting Commission;

“The Office of the NBTC” means the Office of the National Broadcasting and Telecommunications Commission;

“Competent official” means an official appointed by the Commission to undertake duties under this Notification.

CHAPTER I

Criteria and Procedures for Licensing Application

Clause 5 Any person who intends to provide a radio or television broadcasting network shall obtain a radio or television broadcasting business license for the network provider from the Commission in accordance with the criteria and procedures prescribed in this Notification or any other criteria, procedures or conditions as further prescribed by the Commission.

Unofficial Translation

Clause 6 Qualifications of the applicant:

In addition to having the qualifications and not being under any prohibitions as prescribed under Section 8, Section 11, Section 12, Section 13, Section 14 and Section 15 of the Broadcasting Business Act B.E. 2551 (2008), the applicant shall have the qualifications and shall not possess the prohibited characteristics as follows:

(1) the applicant shall not be a bankrupt or have its properties seized by a court order or be placed under a receivership or business reorganization order by a court under the bankruptcy law;

(2) the directors or persons in authority of the applicant shall not be a person listed by the Securities Exchange of Thailand as a person not suitable for holding a management position under the rule of the Securities Exchange of Thailand;

(3) the applicant, directors, managers or persons in authority of the applicant shall not be a person sentenced by a final judgment for a criminal offence committed under the law on broadcasting business, the law on radiocommunications, the law on telecommunications business, the law on trade competition, the law on information, the law on property rights, the law on narcotic drugs, predicate offenses under the anti-money laundering law, offenses related with competent officials under the Penal Code, offenses under the law on placing of bids to state agencies and offenses under the organic law on anti-corruption within two years before the date of application.

Clause 7 Any person who wishes to provide a network service under this Notification shall apply for a license from the Commission.

(1) Submit an application for the license according to the forms prescribed by the Commission as attached to this Notification. The application must clearly identify the service coverage areas;

(2) Submit completed application forms and relevant documents or necessary information for the licensing according to Clause 8 together with one each of hard copy and electronic copy. Submission may be made in person or by registered mail to the Office of the NBTC;

(3) The applicant shall pay for application processing fee as set out in Annex A on the submission date or as prescribed by the Commission.

If it is deemed appropriate to change the licensing application criteria and procedures relating to certain categories of radio or television broadcasting facility services, for the purposes of supervision or any other public interest, the Commission may do so and make announcement in advance.

Unofficial Translation

Clause 8 Relevant documents and information necessary for licensing application are as follows:

The applicant shall submit the relevant documents and information necessary for consideration of the Commission. At a minimum, the following information must be submitted:

(1) Credentials of the applicant;

(1.1) A copy of corporate registration certificate, memorandum of association and corporate regulations,

(1.2) A copy of national identification card and household registration of the person in authority of the juristic person,

(1.3) In the case of giving another person the authority to act on the applicant's behalf: letter of attorney together with a copy of national identification card; a copy of household registration of both the authorizing and the authorized person,

(2) Information on management and administration;

(2.1) Organization chart,

(2.2) Corporate profile according to Annex B which at a minimum shall consist of the following information:

(2.2.1) a name list, residential address and nationality of the person in authority of the applicant and of the board of directors,

(2.2.2) a name list, residential address and nationality of the investors or holders of equity shares, shareholding proportion of the applicant, voting rights of the investors or holders of equity shares under the law or rules or agreement of the applicant,

(2.3) Financial status examined by a certified public accountant, i.e. balance sheet, income statements, cash flow statements and financial ratio information calculated from the said reports; revenue structure classified by types of services including analysis report or opinions useful for assessing financial status and operating performance of the applicant.

Submission of the above-mentioned reports and information shall contain five-year information. In the case of a juristic person established for less than five years, the information submitted may be in accord with the time of establishment as detailed in Annex C of this Notification.

Juristic person established for less than one year may submit its major shareholders' financial status and operating performance in the past three years including information that demonstrates its financial potentialities, i.e. details of credits obtained from financial institutions and bank statements in confirmation of bank deposits.

Unofficial Translation

(3) Operational plan;

(3.1) Applicant shall submit a network services plan that reflects the objectives of services, service coverage areas, quality of services, marketing policy or competition including service development plan, guidance for consumers protection or complaint handling in order to ensure justifiable quality of services over the terms of services. The said services plan must be in accord with the investment plan under (3.2),

(3.2) Applicant shall submit an investment plan and funding development plan including other relevant information to reflect the feasibility of the plans. At a minimum, the information must demonstrate sources of funds, knowledge and expertise of the executives, hypotheses underlying the planning, risk factors that may have effects on the plans and its business development directions,

The submission of reports and information under (3.1) and (3.2) must be in accordance with Annex C.

(4) Technical and technological information are as follows:

(4.1) Network architecture in accordance with Annex D consists of network equipment and interconnection of the equipment or as set forth by the Commission,

(4.2) Service coverage areas in accordance with Annex E,

(5) Financial status examined by a certified public accountant and information on previous services consistent with the financial statements;

(6) Investment plan and funding plan;

(7) Forecasts for future financial status;

(8) Any other information as specified by the Commission.

Clause 9 Licensing procedures are as follows:

(1) The competent official or the person appointed by the Commission examines the accuracy and completeness of the filled application forms and relevant documents required for the consideration within fifteen working days from the date of submission. An extension of time may be done for no more than seven working days;

(2) If it appears that the application forms and relevant documents required for the consideration are inaccurate or incomplete or inadequate, the competent official or the person appointed by the Commission shall notify the applicant to correct the application forms or submit additional relevant documents necessary for consideration within fifteen working days, and shall not consider forwarding to the Commission unless the relevant documents have been corrected or necessary documents are sufficient for consideration;

(3) If the requirements according to (1) and (2) are correct and complete, the competent official or the person appointed by the Commission shall conduct a review in order to prepare an analysis report on the feasibility of the radio or television broadcasting

Unofficial Translation

network services and draft a license including conditions which will be submitted to the Commission for consideration within sixty working days. A request for an extension of time may be submitted to the Commission in advance before due date. Each time extension must not exceed fifteen days and not more than twice. At a minimum, the following factors shall be taken into consideration:

(3.1) objectives of the business, demands of the consumers in the servicing areas, benefits for the consumers, service users, industries, socio-economic benefits, education, cultures, state security and other public interests,

(3.2) management competencies, financial status and stable operational results that can ensure continued business operations,

(3.3) suitability and consistency of investment plan and service plan that will enable new product and technological development,

(3.4) abilities in mobilizing funds for the operations in accordance with the investment plan both under normal situations and unanticipated conditions that may occur,

(3.5) justifiable technical plan in accord with servicing plan which will ensure efficient use of resources,

(3.6) abilities to install the networks including any other undertaking in accordance with the proposed plan,

The competent official or the person appointed by the Commission shall propose relevant recommendations to the Commission within a reasonable timeframe but no more than fifteen days after the duration specified in (3) paragraph one has lapsed;

(4) Upon obtaining recommendations from the competent official or the person appointed by the Commission, the Commission shall consider the application within thirty days with due regard to the factors in (3) as well as public interests, free and fair competition, universal service obligation provision, efficient use of the network, including entry into the market by new operators especially small and medium enterprises, equitable distribution of benefits and reduction of anti-competitive conduct. The Office of the NBTC shall inform the applicant of the Commission's decision in writing and publicly disclose the information and results of the consideration through the Office of the NBTC's website within fifteen working days;

(5) In the case where the Commission deems it appropriate to instruct the applicant to revise its proposals, the applicant shall submit the revised proposals within thirty days after the date of having been notified by the Office of the NBTC, or as specified by the Commission, for the Commission's reconsideration;

(6) In the case where the Commission deems it appropriate to grant a license, it may set out conditions that the operator conducts a test run for not less than thirty days. The applicant shall thereby conduct its test run within one hundred and eighty days from the date

Unofficial Translation

of notification. If there is disturbance occurred during the test run period, the applicant must solve the problem within fifteen days after the disturbance has occurred;

(7) When the Commission has granted a license under this Notification, it shall be deemed that the applicant has been granted a license to have and use radiocommunication equipments and set up a radiocommunication station under the law on radiocommunications. The permit however is restricted only to the radiocommunication equipments as specified in the application forms. The applicant shall pay for license fees and other expenses at the rates prescribed by the Commission within fifteen days after the date of receiving the notice.

Clause 10 The person granted a license to operate telecommunications business or the person granted a permission, concession or contract as the telecommunications business operator under Section 80 of the Telecommunications Business Act B.E. 2544 (2001) who intends to provide the network services shall obtain prior permission from the Commission under this Notification.

The licensee under paragraph one shall be liable for payment for operation fees at a rate of two percent of revenues before expenses generated by the business permitted under this Notification before all expenses are deducted, or as prescribed by the Commission.

CHAPTER 2

Rights and Duties of Licensees

Clause 11 A person licensed to provide the radio or television broadcasting network services may build or procure broadcasting facilities for use in its service provision in accordance with the criteria, conditions and procedures set forth by the Commission concerning the rights to setting up or erecting poles, laying lines, placing ducts, or installing associated equipment for the broadcasting services.

Clause 12 Scope and conditions of licensing:

(1) Licensee shall have all qualifications as prescribed in Clause 6 during the term of the license;

(2) The license is restricted right of the licensee and shall not be transferable. The licensee must undertake the business by itself and is neither allowed to authorize administrative power, either totally or partially, to other persons, nor to permit other persons to operate the business on its behalf. Transferring the right either in whole or in part to other persons that causes an impact on the licensed business undertaking is prohibited;

Unofficial Translation

(3) Licensee shall start its operation in order to provide the licensed services in accord with the service plan and investment plan within two years as from the date of obtaining the license and submit performance report on a monthly basis until the services are functional, unless otherwise prescribed by the Commission;

(4) Licensee shall provide interconnection system of the set of transmitters or audio or visual broadcasting equipment being used for broadcasting open news and information or programs from a station to receiving apparatus through any of wire, radio frequency, optical, electromagnetic waves, or other means;

(5) In the case that a licensee wishes to provide additional network services after having been granted a license, the licensee may request to the Commission for consideration by which the provision of Clause 9 shall apply *mutatis mutandis*. In obtaining the permission, licensee shall pay additional license fees as set out by the Commission;

(6) Licensee shall be able to provide the network services over the period permitted by the Commission. In the case where the licensee wishes to terminate the services before the expiry of the license, he is obliged to notify the Commission in advance for its endorsement by explaining reasons for closing the business together with measures for remedying the service users. The licensee must act in accordance with conditions set out by the Commission before closing the business;

(7) Licensee shall be liable for paying annual license fees at a rate of two percent of revenues before expenses are deducted and have the duty to value the amount of such fees and prepare details of the calculation in accordance with the submission made with the Office of the NBTC. If such fees were not paid within a specified time, the licensee shall be liable for paying additional fees at a rate set out by the Commission. Otherwise it shall be deemed that the applicant gives up its right to apply for a license.

In the case where the licensee fails to pay in full within fifteen days after the due date, the license shall be void as from the day following the date due. The person shall act in accordance with the conditions set forth by the Commission before business closure.

For the purpose of the licensee's annual fee calculation, the licensee shall submit annual financial statements examined by certified public accountant to the Commission which clearly separate costs and revenues by types of licensed services, or other information necessary for the consideration of license fee setting as determined by the Commission;

(8) Licensee shall have the duty to allot an annual funding support to the Broadcasting and Telecommunications Businesses Research and Development Fund for Public Interest at a rate of two percent of revenues before expenses are deducted or as set out by the National Broadcasting and Telecommunications Commission;

(9) Over the period of licensed services, the applicant must employ telecommunication or communication and electronic engineers to control its technical operations;

Unofficial Translation

(10) Licensee shall provide its network only to those radio or television broadcasting operators who have been licensed by the Commission;

(11) Licensee shall provide its network for other licensees on an equitable basis and shall not be discriminating against or restricting other operators. If it is not possible to support, the licensee must give reasons for the refusal to the Commission;

(12) In undertaking the licensed business, licensee shall prepare proposals for using or connecting broadcasting networks for the Commission's endorsement and disclose to the public to allow other licensees to consider before using or connecting with the networks;

(13) Licensee must allow other licensees who operates radio or television broadcasting business to use or connect partial network;

(14) Licensee shall have the duty to relay signals for free broadcasting services under the Notification of the National Broadcasting and Telecommunications Commission on the Criteria for Free Television Broadcasting, or as prescribed by the Commission;

Network provider who sets out conditions for access or use of service under paragraph one shall include attaching conditions for use of radio or television services whereby the provider does not intend to provide free broadcasting services, irrespective of whether or not service charges will be imposed;

(15) Licensee must suspend broadcasting any programs as stipulated in Section 37 paragraph one of the Broadcasting Business Act B.E. 2551 (2008) which is transmitted or broadcasted through the licensee's networks;

(16) In the case where there is disaster or emergency or necessity for public interest, licensee shall have the duty to broadcast, inform or warn the public upon request by the Government and relevant state agencies, or as prescribed by the Commission;

(17) In the case where a licensee has undertaken a merger or become a trading partner with other licensee or entered into an agreement granting the other party the power to control, direct or act on its behalf or to have access to trade information, prior approval from the Commission is required.

In the case where the Commission considered that the act according to paragraph one has resulted in, or may lead to restriction of fair competition, the Commission may set forth specific measures to be complied by the licensee;

(18) Licensee shall comply with the law on trade competition and shall not take any action deemed by the Commission that such action has or may have an aim or significant impact on fair competition in the supply of networks, facilities and radio or television broadcasting services licensed to the licensee or broadcasting devices of other persons including the following cases:

Unofficial Translation

(18.1) Making a contract or entering into any other agreement in a collusive manner, or cooperating with other persons that causes effect on competitiveness of other licensees and consumers,

(18.2) Making a contract or entering into an agreement with any other persons relating to service charges or fees or broadcasting devices in the manner of destroying, restricting, impeding or obstructing fair competition or obstructing the new entrants to the market,

(18.3) Affording not to sell or provide services to other licensees or other persons who are not their own subsidiaries or affiliates,

(18.4) Taking action that results or may result in restricting any of other licensees to have an access to the services,

(18.5) Making contract or entering into an agreement with other broadcasting operators or providers of broadcasting devices to divide market shares by fixing geographical areas or any other means considered by the Commission as a collusive market sharing or unlawful market organization,

(18.6) Unjustly giving privileges or taking benefits from affiliate companies or any discriminatory practices that have impacts on fair competition in the market if the Commission considers that other licensees may fall under serious disadvantage at the competition, or that it would cause significant reduction in competition, or that it would result in the restriction of market entry of new operators,

(18.7) Any other act that results in service subsidization, cross-service subsidization, holding business of the same category, abuse of market power, market dumping, price cutting lower than its costs, price setting at a rate that restricts competitiveness of other licensee or price discrimination.

(19) Licensee shall disclose information on the utilization of necessary networks to the Commission on a half yearly basis;

(20) Licensee shall act in compliance with the regulations, rules, notifications, ordinances or measures prescribed by the Commission with regard to the following matters:

(20.1) Free and fair competition,

(20.2) Use of broadcasting resources,

(20.3) Access and interconnection of the broadcasting services,

(20.4) Exercise of right to setting up or erecting poles, laying lines, placing ducts, or installing associated equipment for the broadcasting services,

(20.5) Provide universal service obligation,

(20.6) Consumers protection,

Unofficial Translation

(20.7) Action in case of emergency or disaster,

(20.8) Fees and service charges,

(20.9) Dispute resolution,

(20.10) Relevant technical standards,

(20.11) Criteria or any other measures as further set forth by the Commission,

Over an annual accounting period, the licensee must prepare a report on number of service users, financial status showing expenses and incomes, costs classified by types of network services which have been examined by certified public accountant. The licensee must also confirm the total revenues derived from the licensed services by informing the Office of the NBTC in writing within ninety days as from the day following the ending of an annual accounting period at the licensee's own expenses;

(21) Licensee shall carry on maintenance, service and improvement of the broadcasting networks in order to provide efficient and sustainable services over the licensed period;

(22) Licensee shall expand its networks in accordance with the service plan endorsed by the Commission;

(23) Licensee shall install networks and equipment to support the radio or television services in accordance with the radio frequency plan prescribed by the Commission;

(24) Licensee shall provide networks with the facilities that are licensed by the Commission only;

(25) The Commission may set out categories or orders of radio or television broadcasting services for use in providing network services. Licensees are prohibited from taking any advantages from such categorization or service prioritization;

(26) For promotion and development of the broadcasting business or for public interests, licensees have to make available channels for providing radio or television services as prescribed by the Commission;

(27) Licensee located in aviation safety zone who intends to install or change the antenna's height of radio station shall seek approval from responsible agency under the law on aviation prior to submitting an application for establishing a radiocommunication station with the Commission;

(28) Erecting or constructing an antenna tower shall be under the law on building control;

(29) Licensee shall strictly adhere to the conditions set forth in the license by the Commission.

Unofficial Translation

Clause 13 In case of crises or necessity for protecting public interests or change in legislation or circumstance, the Commission shall have the power to amend the scope and conditions of the license as necessary.

Clause 14 Licensee shall not suspend or end the provision of services, either in whole or in part, unless permission has been granted by the Commission.

Clause 15 Term of the license:

A network service license shall have a term not exceeding fifteen years as from the date of granting.

Clause 16 Submission of a renewal application:

In the case of an expiry of the license under Clause 15, if the licensee intends to continue the network provision, the licensee shall submit a renewal application with the Commission in accordance with the following criteria, procedures and conditions:

(1) Licensee shall submit an application at least ninety days but not more than two years prior to the existing license's expiry, together with relevant documents or information necessary for licensing as set forth in Clause 8;

(2) An applicant for license renewal shall have qualifications as prescribed in Clause 6 and never been considered by the Commission that the applicant failed to comply with the conditions set out in the broadcasting business license under this Notification;

(3) The provision in Clause 9 shall apply *mutatis mutandis* to the procedure for license renewal approval. A final consideration shall be made by the Commission within sixty days after the date of receiving the application;

(4) During the time the renewal application is being considered according to (3), the licensee may continue its services until the Commission issues an application refusal order. In such case, the applicant for license renewal shall be liable for paying proportional fee for the operations conducted;

(5) The term of the renewed license may be varied from the previous license which shall be determined by the Commission.

CHAPTER 3

Supervision and Regulation

Clause 17 Licensing expiry: apart from termination of a license according to Clause 15, the radio and television broadcasting network service license may be void for the following reasons:

Unofficial Translation

(1) Licensee has notified its termination of services and complied with the conditions set forth by the Commission prior to the business closure;

(2) The Commission revoked the license due to a failure to observe the conditions set out in the criteria prescribed by the Commission.

Clause 18 Where it appears to the competent official that the licensee violates or fails to comply with the conditions set out under this Notification or criteria prescribed by the Commission, the competent official shall have the power to issue a written warning or order the licensee to refrain from violating act, rectify, improve, or act in correct or appropriate manner within timeframe prescribed including the power to calling any person to give statements or to furnish documents or any materials for consideration.

Clause 19 If the licensee who received the competent official's order according to Clause 18 is not satisfied with such order, the licensee has the right to appeal the order with the Commission within fifteen days after the date of receiving the order. The decision of the Commission shall be final.

In the case where the licensee continues neglecting to act in compliance with the order or it is the case of serious damage to the public interests, the Commission shall have the power to suspend or revoke the license. Each suspension must not be longer than one month.

The law on administrative procedure shall apply *mutatis mutandis* to the implementation under paragraph two.

Clause 20 The licensee shall have the duty to arrange remedial measures for the impact that may cause to the service users following the licensing termination under this Notification and shall include the case where the services are either fully or partially suspended or stopped.

Transitory Provisions

Clause 21 The broadcasting business operators, who have lawfully provided network services when this Notification comes into force, who wish to continue their service provision, shall file an application for a license in accordance with this Notification within sixty days from the date this Notification takes effect. Upon submitting the application for a license with the Commission, the said operators shall have the right to continue the services until the Commission notifies them of the decision not to grant a license.

Clause 22 The persons licensed to operate the telecommunications business or the persons granted a permission, concession or contract as the operators under Section 80 of the Telecommunications Business Act B.E. 2544 (2001), who have lawfully provided

Unofficial Translation

network services when this Notification comes into force, who wish to continue their service provision, shall file an application for a license in accordance with this Notification within sixty days from the date this Notification takes effect. Upon submitting the application for a license with the Commission, the said operators shall have the right to continue the services until the Commission notifies them of the decision not to grant a license.

Announced on the 5th day of October B.E. 2555 (2012)

Colonel Natee Sukonrat

Chairman of the Broadcasting Commission

For Chairman of the National Broadcasting and Telecommunications Commission

Unofficial Translation

Annex A

Licensing Application Fee

.....

Types of Business	Fee
Network provider	
Local level	10,000 Baht
Regional level	100,000 Baht
National level	500,000 Baht
Community service (community radio)	2,000 Baht
Producing a duplicate copy of license	1,000 Baht
Photocopying a license	500 Baht

Unofficial Translation

Annex B

Corporate Profile

.....

Corporate Profile contains details as follows:

1. Shareholding structure, name list, and shareholding proportion of the applicant's major shareholders, minor shareholders, parent company, subsidiary company and associated company.

2. Details of the executives and person(s) having controlling power of the applicant:

2.1 Fill in details of the executives or person(s) having controlling power in the table below:

Name/ surname/ position (a)	Shareholding proportion (b)	Family relationships among directors (c)	Work experience in the past 5 years		
			Periods	Position	Name of agency/company/ type of business (d)

Remarks: (a) For the directors, please specify the categories of directors, for example, director in authority of the company as set out in the letter of certification,

(b) Include shares of spouse and child who is a minor,

(c) Identify family relationship among the directors. Family relationship means relatives by blood, marriage and legal registration. Please specify only connection in order of father, mother, spouse, child, sibling, uncle, aunt, including spouse and child of these persons,

(d) Specify only experience related with radio or television business.

2.2 If the executives and person(s) having controlling power are holding management positions in many subsidiary, associated or related companies (which were licensed or are applying for a license to operate broadcasting business or having related business with the company who is applying for a license), please fill in details of the executives and person(s) having controlling power in the table below:

Unofficial Translation

Information on management positions held by executives and person(s) having controlling power

Name of company/ Name	Subsidiary company			Associated company			Related company		
	Company A	Company B	Company C	Company D	Company E	Company F	Company G	Company H	Company I
Example: Mr. A Mr. B	**	*		***			*		
	***				***	***			

Remarks: Add tables for more information

*= Chairman

**= Executive Board Members

***= Directors

3. Details of subsidiary company that was licensed to operate broadcasting business or that is applying for a license or doing business related with the applicant's company:

Details of the subsidiary company's directors

Subsidiary companies Directors	Company...	Company...	Company...
Example: Mr. A Mr. B	*	**	***
	**	*	

Remarks: Add tables for more information

*= Chairman

**= Executive Board Members

***= Directors

4. Related Party Transactions (if any)

Describe past related party transactions and policies on conducting related party transactions with persons who may have conflicts of interest at least as follows:

4.1 Disclose related party transactions conducted with a person or group of persons who may have conflicts of interest in the previous year by identifying names of a person or group of persons who may have conflicts of interest, nature of relationships (e.g. being the major shareholder's father, being a company in which the major shareholder holds more than 30 percent shares) and disclosing information on the related party transactions, e.g. nature, volume, conditions of the transactions, interest rate, buying price, selling price, value of the related party transactions, or actual rents incurred

Unofficial Translation

as well as showing assessed price or rental rate assessed by a third party or proven that it is a fair price. In the case of related party transactions conducted with associated or subsidiary company in which the executives, major shareholders, persons with controlling power of the company applying for a license hold less than 10 percent shares in total, disclosure of information may be abstained;

4.2 Describe the necessity and justification of the said transactions as to how these transactions are conducted for the company's maximum benefits. If any independent director had expressed different opinions from the board's resolution, his opinions must also be disclosed;

4.3 Describe measure or procedures for approving related party transactions, and state that whether or not the executives of shareholders who have interest in these matters took part in the approval and elaborate how these matters were handled;

4.4. Describe the policies or future directions of the conduct of related party transactions.

Remarks:

If related party transactions under 4.1 were fully disclosed in the footnotes to financial statement, disclosure of information in this part may be abstained and reference should be made to the relevant footnotes.

Related party transaction means a similar or competitive transaction or business or any other relation that may create conflicts of interest between the company (i.e. the company applying for a license or subsidiary company) and a person or group of persons who may have conflicts of interest. The related party transactions subject to disclosure of information are listed below as examples;

- (a) providing or receiving products and services,
 - (b) permitting use of property,
 - (c) property trading,
 - (d) sources of the capital,
 - (e) being an agent,
 - (f) guaranteeing/ warranting,
 - (g) long term leasing,
 - (h) entering into management contract,
 - (i) providing or receiving information from research and development,
 - (j) permitting the right to use intellectual property,
5. Details of connected persons

The applicant must provide name list and details of connected person or group of persons, i.e.

5.1 The executives and those executives who are relatives of the major shareholders, persons with controlling or supervising powers of the company, or persons being nominated to become

Unofficial Translation

executives or controllers of the company applying for license, or of subsidiary company, including related and close relatives of the said persons;

5.2 Any juristic person whose major shareholders or controllers have the following roles in the company applying for a license or in the subsidiary company:

- (a) an executive,
- (b) a major shareholder,
- (c) a person with controlling and supervising powers, or an authorized person,
- (d) a person being nominated to become the executive or person with controlling and supervising power, or an authorized person,
- (e) a close relative and related person of the persons listed above,

5.3 Any person whose act indicates that he is acting for, or under the influence of the persons under 5.1 or 5.2 in making significant decisions, directing policies, management or operations, or other persons who take a similar act, such as advisers, coordinators or nominees.

6. Definitions

“parent company” means

- (a) a company which holds more than 50 percent of the total voting shares in the juristic person applying for a license,
- (b) a company which holds more than 50 percent of the total voting shares in the company under (a),
- (c) a company which holds shares in chains, beginning from the company which holds shares in the company under (b), each chain of which is more than 50 percent of the total voting shares in the company whose shares are held,
- (d) a company which directly or indirectly holds more than 50 percent of the total voting shares in the juristic person applying for a license,

Shareholding of the company under (a), (b), (c) or (d) includes shares held by a connected person.

“subsidiary company” means

- (a) a company in which the company applying for a license holds more than 50 percent of its total voting shares,
- (b) a company in which the company under (a) holds more than 50 percent of its total voting shares,
- (c) a company whose shares are held in chains, beginning from the company under (b) holding shares in the company whose shares are held, each chain of which is more than 50 percent of the total voting shares in the company whose shares are held,

Unofficial Translation

- (d) a company in which the company applying for a license or company under (a), (b) or (c) directly or indirectly holds more than 50 percent of its total voting shares,
- (e) a company in which the company applying for a license or company under (a), (b) or (c) has controlling power in the direction of the company's financial policies and profit-making operations from such company's activities,

Shareholding of the company under (a), (b), (c) or (d) includes shares held by a connected person.

“associated company” means

- (a) a company in which the company applying for a license or the subsidiary company collectively holds more than 20 percent but not more than 50 percent of its total voting shares,
- (b) a company in which the company applying for a license or the subsidiary company has the power to involve in the company's financial policies and operations but neither to control such the policies nor to be a subsidiary or joint venture,

Shareholding of the company applying for a license or subsidiary company includes shares held by a connected person.

“major shareholder” means a shareholder which, directly or indirectly, collectively holds more than 10 percent of the total paid-up shares in the company applying for a license, including shares held by a connected person.

“minor shareholder” means a shareholder who, directly or indirectly, collectively holds more than 5 percent but not more than 10 percent of the total paid-up shares in the company applying for a license, including shares held by a connected person.

“person with controlling powers” means a shareholder or other person who has significant influence over the company with authority in the direction of the company's policies, management or operations either such influence has been acquired from shareholding or authorization on contract or any other dealing, particularly the person with the following particulars:

- (a) a person who directly or indirectly holds more than 25 percent of the total voting shares of the company,
- (b) a person who, in practice, has influence over the company's appointment or removal of directors,
- (c) a person who, in practice, is able to control the persons responsible for the direction of policies, management or operations of the company to act on his respective instructions,
- (d) a person who, in practice, takes charge in the company's operations or responsibility for the company's operations as an executive, including the person holding a position with the same authority with such the person.

“connected person” means

Unofficial Translation

- (a) the spouse,
- (b) a minor child,
- (c) an ordinary partnership or registered ordinary partnership in which the company applying for a license is a partner,
- (d) a limited partnership in which the company applying for a license is an unlimited liability partner or a limited liability partner who collectively holds over 30 percent shares of the total shares of the limited partnership,
- (e) a limited company or a public limited company in which the company applying for license, or partnership under (c) or (d) collectively holds more than 30 percent shares of the total shares sold, or paid-up shares of that company, or
- (f) a limited company or a public limited company in which the company applying for license, or partnership under (c) or (d) or company under (e) collectively holds more than 30 percent shares of the total shares sold, or paid-up shares of that company, or
- (g) a juristic person over whom the company applying for a license has the controlling power in its management policy, finance and operations.

“person who may have conflicts of interest” means

- (a) an executive of the company applying for license,
- (b) a major shareholder of the company applying for license,
- (c) a person with controlling powers of the company applying for license,
- (d) a person related by blood, marriage or legal registration with the persons under (a), (b), or (c) namely father, mother, spouse, child or other close relatives,
- (e) any juristic person in which the persons under (a), (b) or (c) hold shares or have controlling powers or any other significant interest either directly or indirectly.

.....

Annex C

**Information on Financial Status Examined by Certified Public Accountant
And Operational Plan**

.....

1. Information on Financial Status Examined by Certified Public Accountant

1.1 balance sheets

1.2 income statements

1.3 cash flow statements and financial ratio information calculated from the said reports

1.4 revenue structure classified by types of services

1.5 analysis report or opinions useful for assessing financial status and operating performance of the applicant

2. Information on Operational Plan

2.1 Service plan that reflects objectives of the services:

- a. objectives of the services,
- b. service coverage areas: clearly describe the details of coverage areas for providing radio or television broadcasting networks,
- c. quality of services, e.g. technology, capacity of networks, service area covering different services, etc.,
- d. market policy or competition: describe in details of rate setting criteria and other relevant conditions,
- e. guidance for consumers protection, e.g. setting up a complaint handling center,
- f. handling of complaints made by service users: describe in details of methods, procedures and handling of complaints made by service users,

2.2 Investment plan and funding plan:

a. details of sources of funds, amount, methods, terms of credit payment (if applicable) consistent with the investment plan under normal conditions and emergent situations,

b. knowledge and expertise of the executives,

c. hypotheses underlying the financial plan:

(1) Macro economic parameters are applied for the calculation, e.g. economic growth rate, inflation rate, interest rate, and exchange rate, etc.

Unofficial Translation

(2) Revenue is a parameter applied for calculating benefits or revenues derived from the project, e.g. demand forecast, targeted services or sales, service charges, etc. However, calculation of benefits or revenues of the project must also take into account other parameters such as technical parameter, capacity in providing services, categories of service users, service users' behaviors, including nature of business.

(3) Expenditure is a parameter applied for calculating costs incurred on the project, e.g. investment costs, operating and maintenance costs, weighted average costs of capital: WACC, principle and interest payment, methods for calculating depreciation costs of the property, including expenditures for environmental protection and treatment (if any), etc. For the purpose, the underlying parameters for key project operation should be used for calculation as well.

d. risk factors should at a minimum include 1) business risks; 2) financial risks; 3) risks incurred from changes to policies, legislations, rules and regulations or other government requirements,

e. overall business development directions set out by the applicant such as opportunities for research and development in the broadcasting services, innovation enhancement, including development of broadcasting services.

Unofficial Translation

Annex D

Network Architecture

(For the business that uses radio frequency)

.....

1. Applicant's network system

2. Details of network equipment

3. Characteristics of network equipment interconnection

4. Network models

Unofficial Translation

Sample: Network Architecture of Analogue Radio

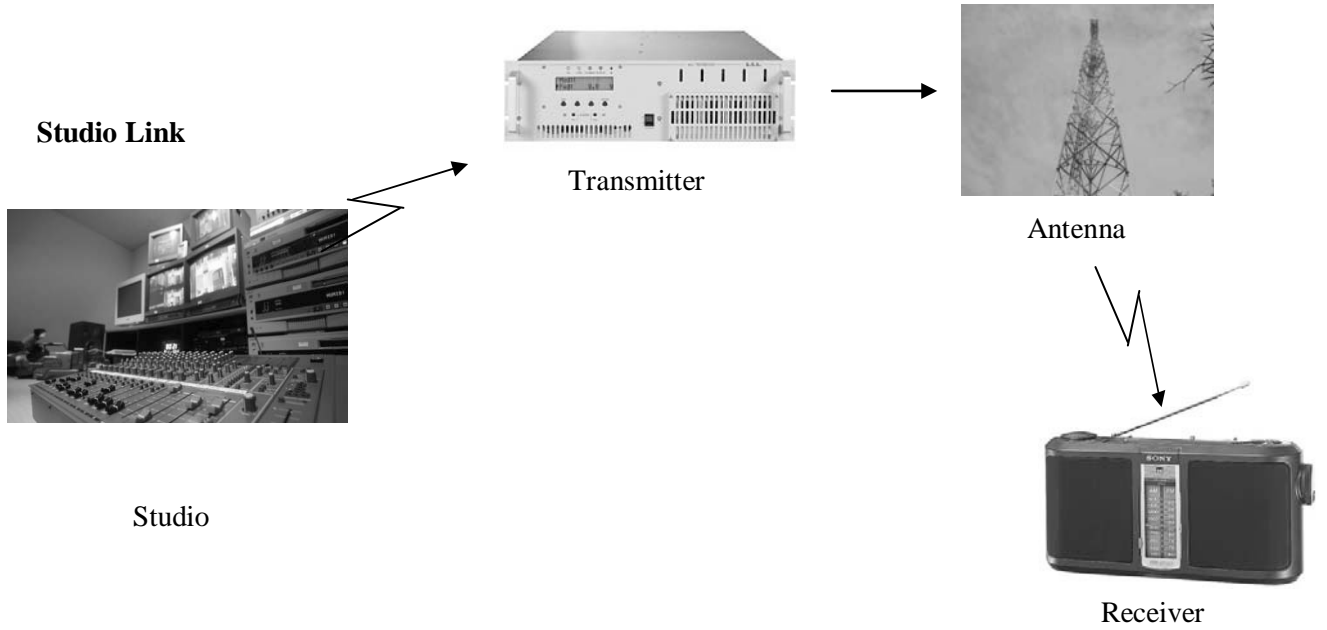
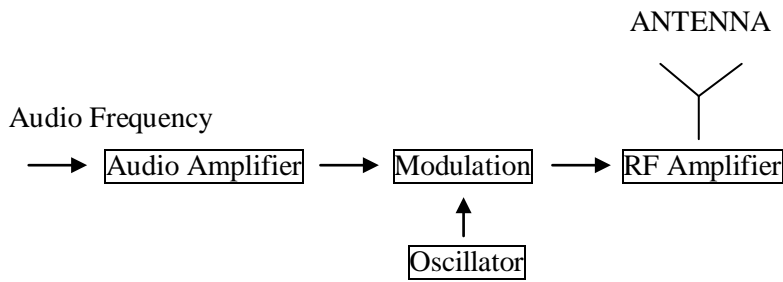

Figure 1 Analogue Network Architecture

Sample: Network Configuration of Analogue Radio



Modulation	Frequency Modulation
Power Output	300 Watts
Antenna Gain	3dBd
Antenna Pattern	Isotropic
Effective Radiated Power : ERP	66 W

Figure 2 Analogue Network Configuration

Sample: Network Architecture of Digital Television

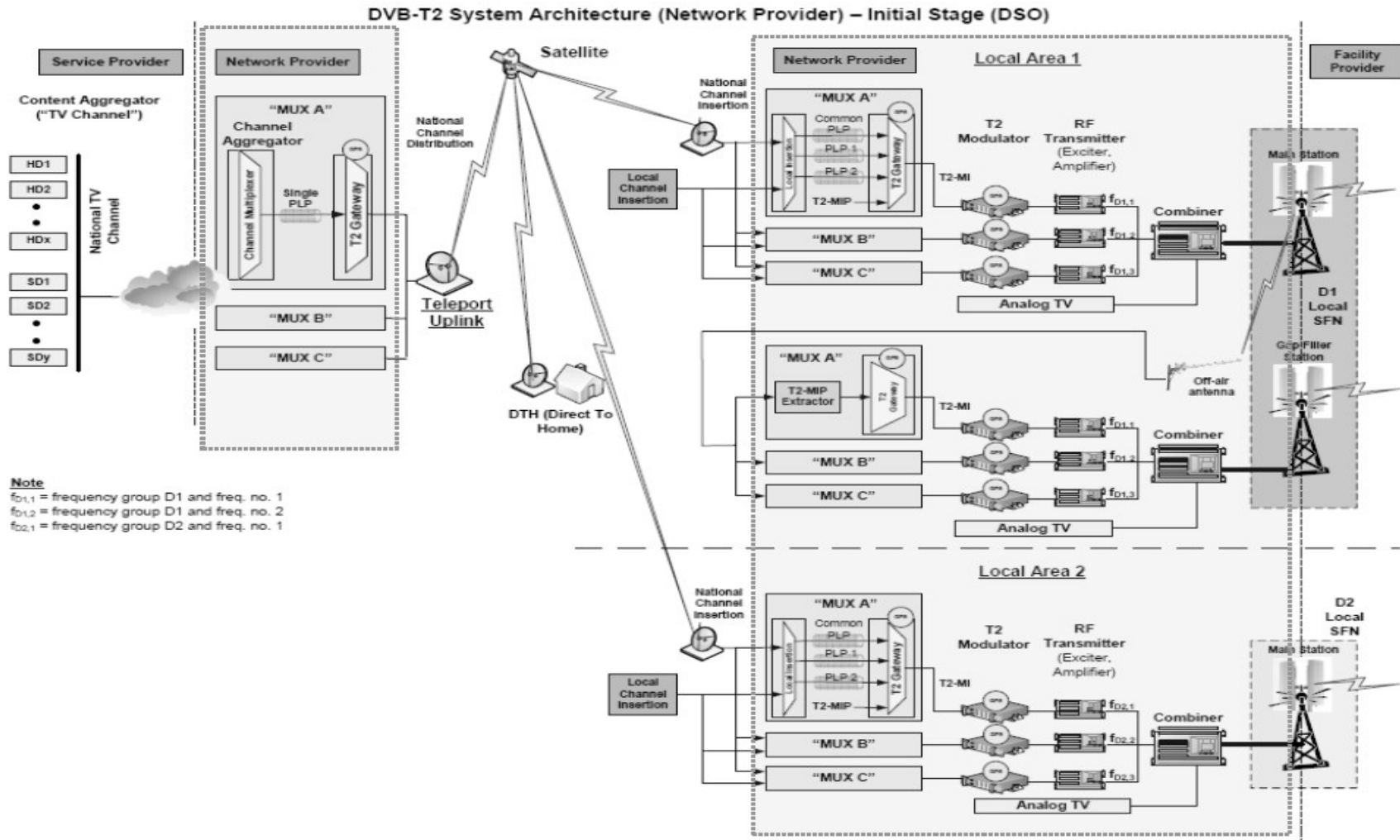

Figure 3 Digital Network Architecture

Unofficial Translation

Network Architecture

(For the business not using radio frequency)

1. Information on transmitter station and repeater station

- 1.1 Identify Geographic Coordinates (latitude and longitude shown with 6 decimal points) and details of the locations of all transmitter stations, i.e. location of building, floor, room, home address, sub-district, district, province, country, etc.
- 1.2 Identify Geographic Coordinates (latitude and longitude shown with 6 decimal points) and details of the locations of all repeater stations, i.e. location of building, floor, room, home address, sub-district, district, province, country, etc.
- 1.3 For the broadcasting satellite network provision, identify Geographic Coordinates (latitude and longitude shown with 6 decimal points) and details of the locations of the uplink station, name of the satellite, country owner of the satellite, position of satellite orbit and downlink station (if any).

2. Network information has the following details:

- 2.1 Provide details of service coverage area of each type of the network. For the broadcasting satellite network provision, identify the Footprint.
- 2.2 Provide a feature of the Network Architect including detailed routing of servicing from transmitter station to receivers. If there are many routings or many linking, all details must also be provided.
- 2.3 Provide details of each type of network provided as follows:
 - 2.3.1 Provide details of the applicant's owned network
 - 2.3.2 If using other provider's network or any other particular group network, provides details of the network or of that particular group network
 - 2.3.3 If using internet network, identify the network on which the ISP – Internet Service Provider transmit its signals
 - 2.3.4 If only partial network is used due to geographical limitations, provide details and demonstrate only the relevant servicing areas
- 2.4 For the service through other network system that uses or does not use radio frequency, details of signal channel, conducted carrier power, direction and type of antenna must be provided.

3. Use of medium in transmitting technical signals:

- 3.1 Identify technology used for transmission. If multi-technologies are applied, identify all.
- 3.2 Provide details of encryption and conditional access (if any).
- 3.3 For the broadcasting satellite network provision, provide details of transponder name, downlink frequency, polarization and symbol rate.

Sample: Network Architecture of Satellite Television

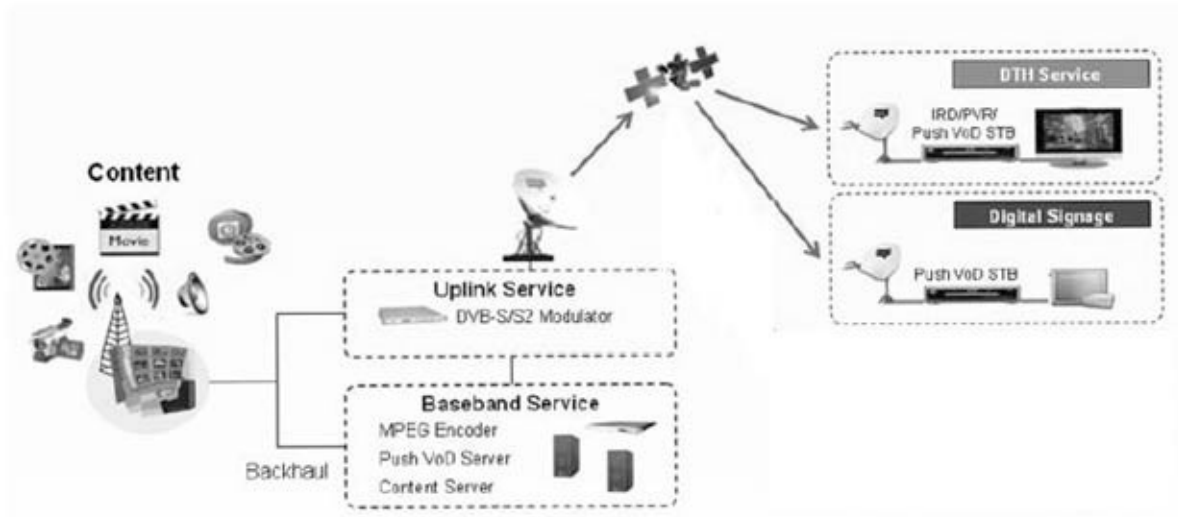

Sample: Network Configuration of Satellite Television

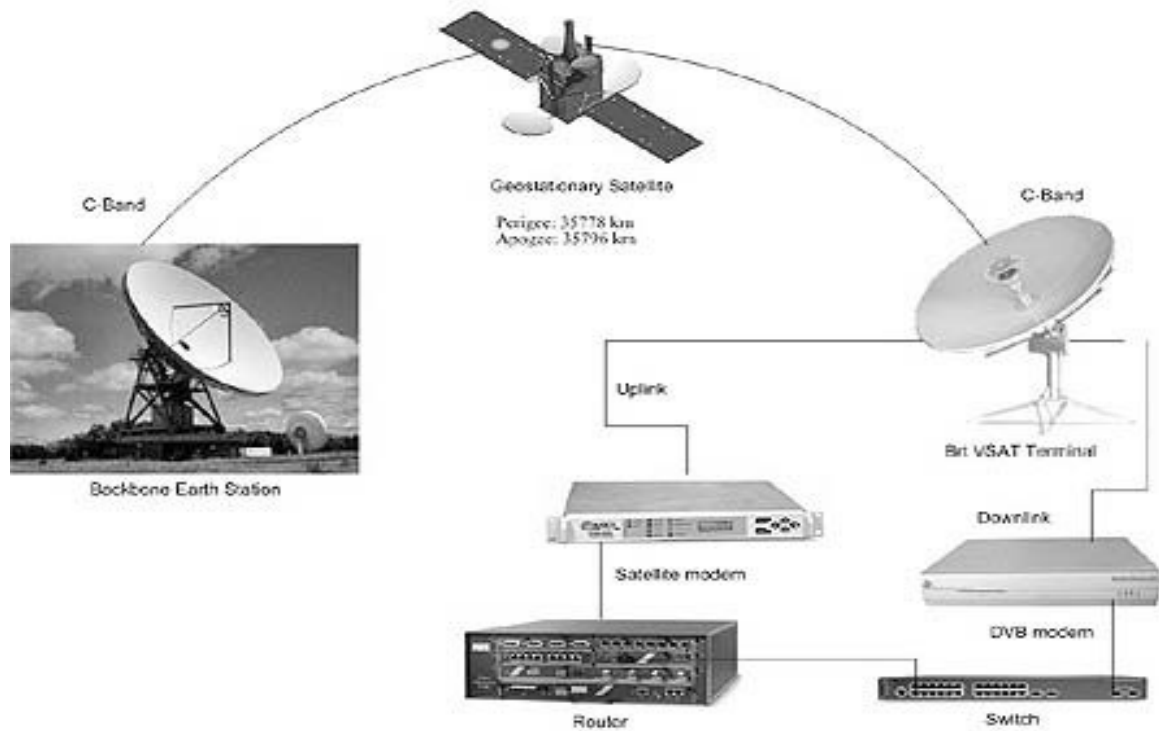

Sample: Network Architecture of Cable Television

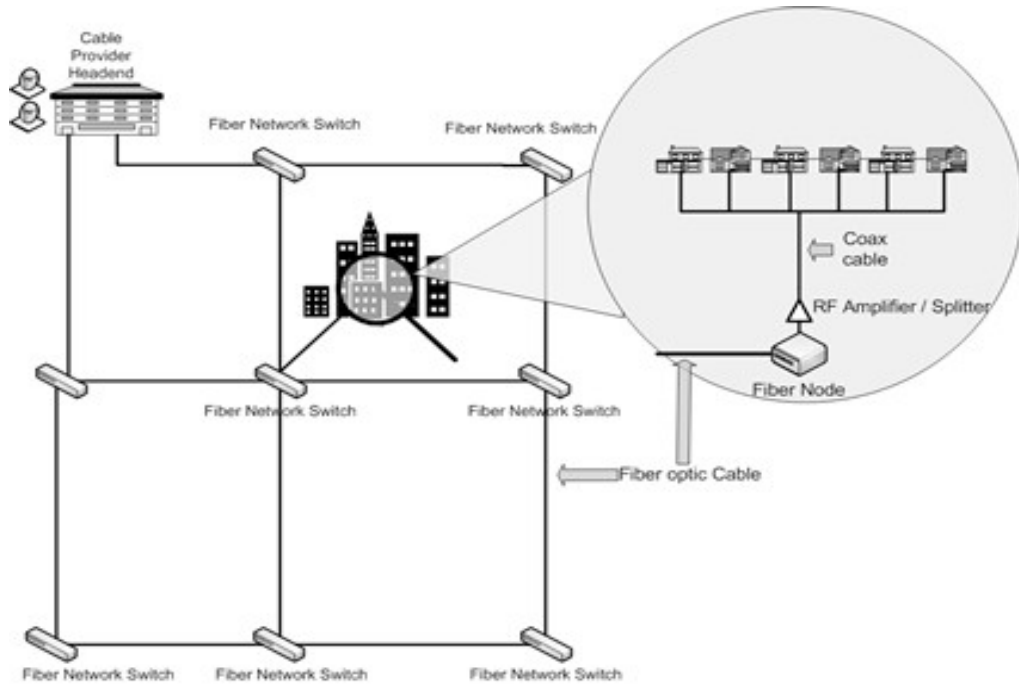

Sample: Network Configuration of Cable Television

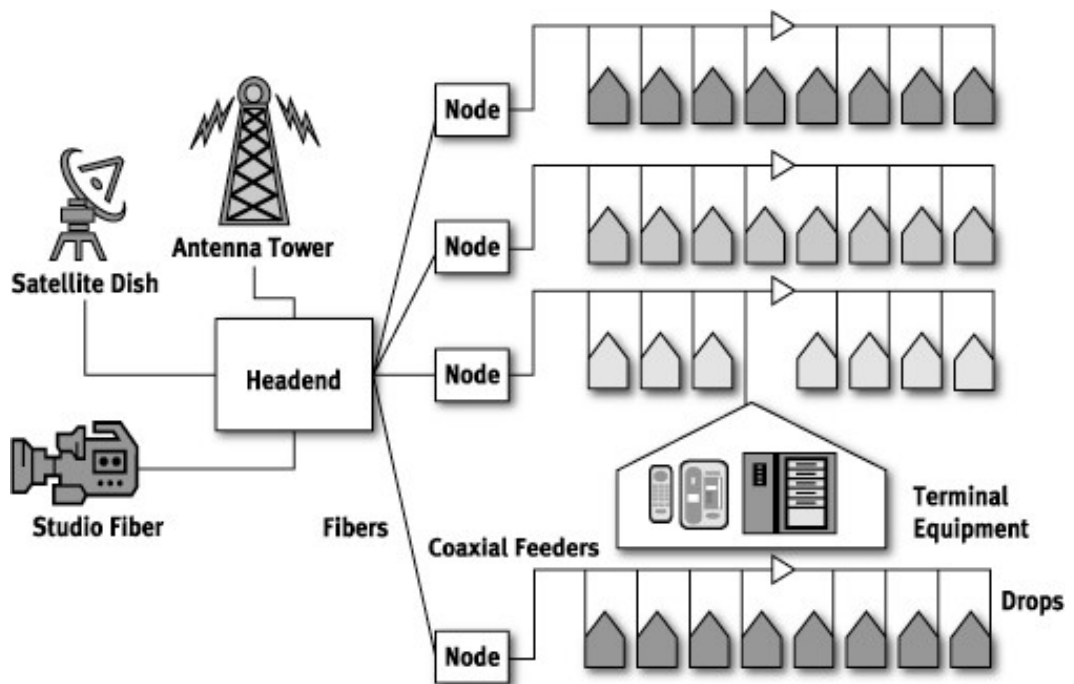

Sample: Network Architecture of IPTV

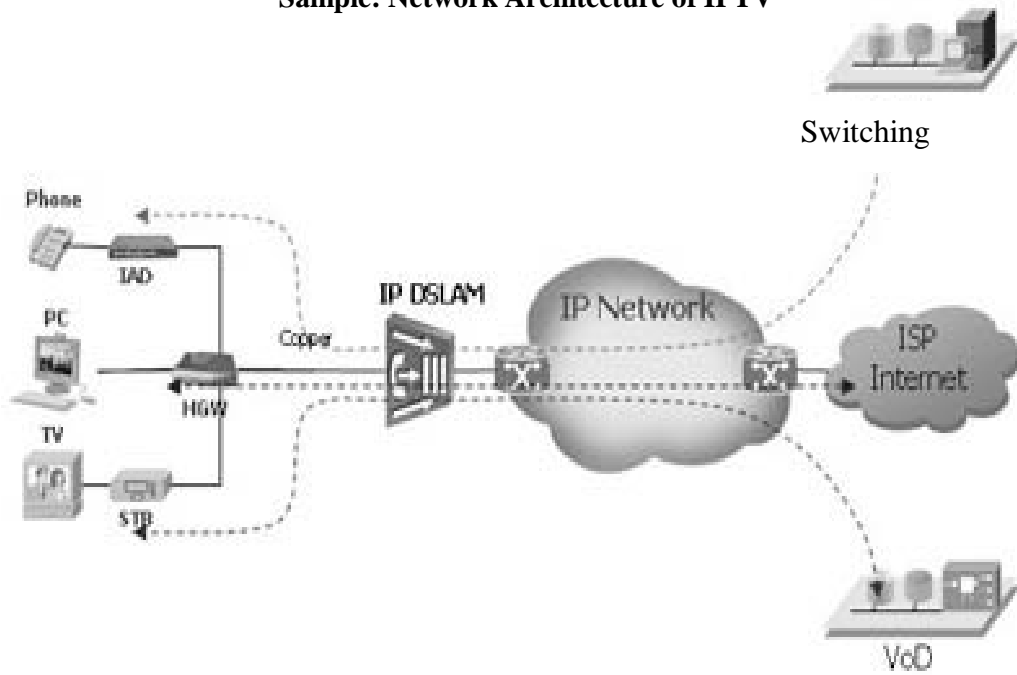

Sample: Network Configuration of IPTV

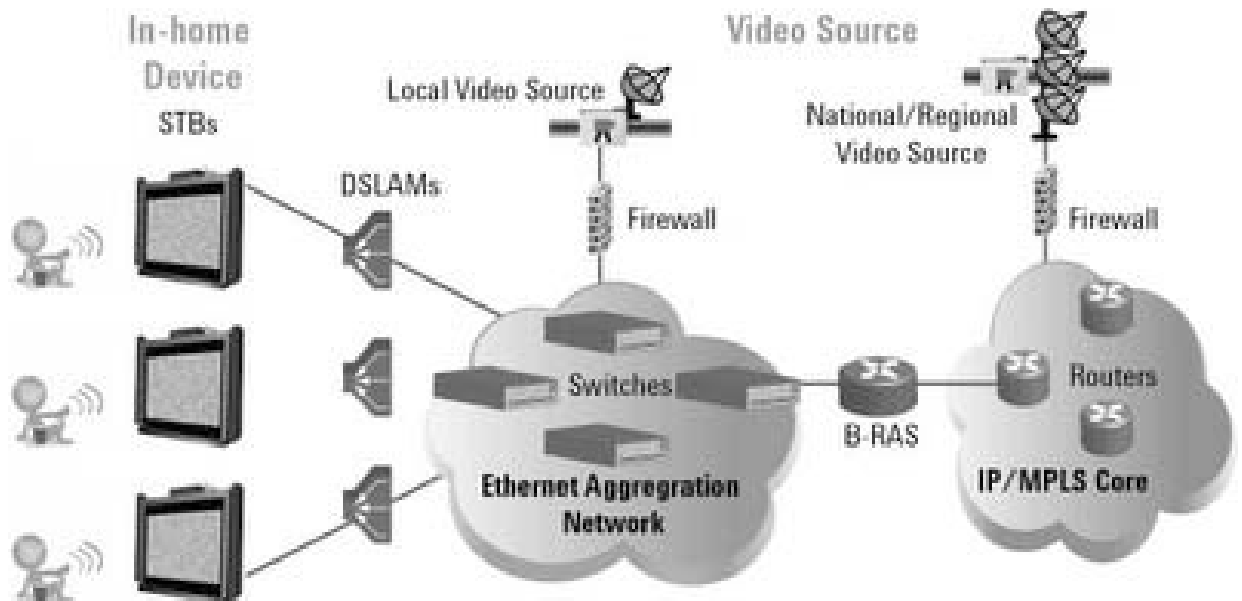

Unofficial Translation

Annex E

Radiocommunication Station and Servicing Areas

.....

For the network that uses radio frequency, the applicant must submit details of the radiocommunication station being used. These must contain details about the radio station and its servicing areas.

The applicant must attach a copy of the license to possess and use radiocommunication equipment and to set up a radiocommunication station, or an application to set up a radiocommunication station.

Name of station	Location		License to set up radiocommunication station	License to use radiocommunication equipment	Service areas	Coverage area	Facility Details
	Address	Latitude/ Longitude					

*Note: Geographic coordinates (latitude and longitude) shown with 6 decimal points

 <p>Office of the NBTC</p>	<p>Application Form For Radio or Television Broadcasting Business License For the Radio or Television Network Services</p>	<p>Document No. Form Por Sor 02</p>
		<p>Page 1 of 7</p>
		<p>Reference No..... Date of submission.....</p>

Application for License

<p>[...] New application</p> <p>[...] Additional application</p> <p style="padding-left: 40px;">[...] Original license No.....</p> <p>[....] Renewal application</p> <p style="padding-left: 40px;">[...] Original license No..... Expiry date:.....</p>
--

Section 1 Applicant's information (Please supply complete details)

<p>1.1 Corporate name</p> <p>Homepage</p>
<p>1.2 Current address/ contact details Address No.....Lane/alley.....</p> <p>Road.....Sub-district/ Township.....</p> <p>District/ City.....Province..... Postal code.....</p> <p>Tel..... Fax:.....E-mail:</p>
<p>1.3 Authorized person's name (1st person).....</p> <p>PositionTel:</p> <p>Fax:E-mail:</p>
<p>1.4 Authorized person's name (2nd person).....</p> <p>Position Tel:</p> <p>Fax:E-mail:</p>
<p>1.5 Authorized person's name (3rd person).....</p> <p>PositionTel:</p> <p>Fax:E-mail:</p>
<p>1.6 Contact person's name</p> <p>PositionTel:</p> <p>Fax:E-mail:</p>

 Office of the NBTC	Application Form For Radio or Television Broadcasting Business License For the Radio or Television Network Services	Document No. Form Por Sor 02
		Page 2 of 7
		Reference No..... Date of submission.....

Section 2 Details of broadcasting networks services (Please supply complete details)

<p>2.1 Clearly specify service area</p>
<p>2.2 Characteristics and types of broadcasting network services</p> <p style="margin-left: 40px;"> [...] To lease audio broadcasting network for radio services [...] To lease television broadcasting network for television services [...] To build new audio broadcasting network for radio services [...] To build new television broadcasting network for television services </p>
<p>2.3 Types of radio or television broadcasting network</p> <p style="margin-left: 20px;"> [...] Wireline network [...] Copper Wire Network [...] Coaxial Network [...] Fiber Optic Network [...] Power Line Network [...] other, specify..... [...] Wireless Network [...] Terrestrial Radio Waves Network [...] Satellite Network [...] other, specify..... [...] Other Network, i.e. </p>

 Office of the NBTC	Application Form For Radio or Television Broadcasting Business License For the Radio or Television Network Services	Document No. Form Por Sor 02
		Page 3 of 7
		Reference No..... Date of submission.....

Section 3 Supporting documents

<p>3.1 Corporate credentials</p> <p>[...] Copies of corporate registration certificate, memorandum of association and corporate regulations</p> <p>[...] Copies of ID card and household registration of person in authority</p> <p>[...] Letter of attorney together with both the assignee's and the authorized person's ID card and household registration (for the case of authorization)</p> <p>[...] Other, specify.....</p> <p>.....</p> <p>.....</p>
<p>3.2 Management and administration</p> <p>[...] Organization chart</p> <p>[...] Corporate profile:</p> <p style="padding-left: 40px;">[...] name, address and nationality of licensee's and directors' person in authority</p> <p style="padding-left: 40px;">[...] name, address and nationality of investor or equity shareholder; licensee's shareholding proportion; voting right of each investor or equity shareholder under the law or rules or agreement of the licensee</p> <p>[...] Other, specify.....</p> <p>.....</p> <p>.....</p>

 <p>Office of the NBTC</p>	<p>Application Form For Radio or Television Broadcasting Business License For the Radio or Television Network Services</p>	<p>Document No. Form Por Sor 02</p>
		<p>Page 4 of 7</p>
		<p>Reference No..... Date of submission.....</p>

3.3 Financial status examined by certified public accountant and information on past services

[...] For juristic person established for more than one year:

[...] Financial statements examined by certified public accountant since the juristic person was set up but not more than 5 years:

[...] Balance sheet

[...] Income statement

[...] Cash flow statement plus financial ratio calculated from the statement

[...] Report on service provision of the applicant since the juristic person was set up but not more than 5 years:

[...] Revenue structure by categories of services, at a minimum, showing items by each category of revenues received from the broadcasting business/ donation/ subsidized funds

[...] Service charge per unit for each type of service that is the source of revenues from the broadcasting business

[...] Number of units for each type of service that is the source of revenues from the broadcasting business

[...] Service costs for each type of service that is the source of revenues from the broadcasting business

[...] Analysis results or opinions useful for assessing financial status

[...] For juristic person established for less than one year:

[...] Financial statements (if any)

[...] Performance of major shareholders of the juristic person since the juristic person was set up but not more than 3 years (if any)

[...] Financial strengths of the juristic person:

[...] Details of credits received from financial institution(s)

[...] Bank statements to confirm deposits with financial institution(s)

[...] Other useful information

[...] Other, specify.....

 Office of the NBTC	Application Form For Radio or Television Broadcasting Business License For the Radio or Television Network Services	Document No. Form Por Sor 02
		Page 5 of 7
		Reference No..... Date of submission.....

3.4 Service plan, investment plan and estimated future financial status

[...] Service plan:

- [...] Objectives of services
- [...] Service coverage area
- [...] Quality of service provision
- [...] Market policy or competition
- [...] Service development plan
- [...] Consumers protection or complaint handling guidance
- [...] Other, specify.....

[...] Investment plan and funding development plan:

- [...] Funding source
- [...] Competencies of the executives
- [...] Hypothesis in formulating detailed investment plan and funding development plan in consistence with estimated future service costs over the term of a license
- [...] Risk factors that may effect the investment plan and funding development plan
- [...] Licensee's business development plan
- [...] Other, specify.....

[...] Estimated financial status in the next 5 years:

- [...] Estimated revenues by categories of services, at a minimum, showing items by each category of revenues received from the broadcasting business/ donation/ subsidized funds
- [...] Estimated service charge per unit for each type of service that is the source of revenues from the broadcasting business
- [...] Estimated number of units for each type of service that is the source of revenues from the broadcasting business
- [...] Estimated service costs for each type of service that is the source of revenues from the broadcasting business
- [...] Estimated cash flow statement or financial status together with hypothesis, financial ratio, investment term and other useful information
- [...] Other, specify.....

 <p>Office of the NBTC</p>	<p>Application Form For Radio or Television Broadcasting Business License For the Radio or Television Network Services</p>	<p>Document No. Form Por Sor 02</p>
		<p>Page 6 of 7</p>
		<p>Reference No..... Date of submission.....</p>

3.5 Technical and Technological Information

- [...] Network Architecture
- [...] Network equipment
- [...] Details on possession and use of radiocommunication equipments and establishment of radio station under the law on radiocommunications
- [...] Points of access to the network and coverage area of network provision
- [...] Other, specify.....

3.6 Information on property right

3.7 Information on universal service obligation

Section 4 Certification of the applicant

- 4.1 I hereby certify that I have all the required qualifications and that all the information and accompanying documentary evidences submitted for consideration are true and complete.
 - 4.2 I agree to have my license revoked or terminated by the Commission immediately if it is subsequently found that any of said qualifications are lacking or any documentary evidences are falsified.
 - 4.3 I agree to oblige to criteria or any terms and conditions related to the allotment of revenues derived from the supply of services to the Broadcasting and Telecommunications Research and Development Fund for Public Interests.
 - 4.4 I have read and understood the criteria under the Notification of the National Broadcasting and Telecommunications Commission on Licensing Criteria and Procedures for Radio or Television Broadcasting Network Services B.E. 2555 (2012) and agreed to oblige unconditionally.
- Signature.....person in authority of juristic person (1st person)
 (.....)
 Day/Month/Year
- Signature.....person in authority of juristic person (2nd person)
 (.....)
 Day/Month/Year
- Signature.....person in authority of juristic person (3rd person)
 (.....)
 Day/Month/Year

 Office of the NBTC	Application Form For Radio or Television Broadcasting Business License For the Radio or Television Network Services	Document No. Form Por Sor 02
		Page 7 of 7
		Reference No..... Date of submission.....

Official Use

Application: <input type="checkbox"/> Complete <input type="checkbox"/> Incomplete	
Required supporting documents: <input type="checkbox"/> Complete <input type="checkbox"/> Incomplete	
Examining official's comments	
Receiving date:	Examining Official:
Assignment memo	Note

This English Translation is prepared with the sole purpose of facilitating the comprehension of foreign participants in the broadcasting rules and regulations and shall not in any event be construed or interpreted as having effect in substitution for or supplementary to the Thai version thereof.

Please note that the translation has not been subjected to an official review by the Office of the National Broadcasting and Telecommunications Commission (The Office of the NBTC). The Office of the NBTC, accordingly, cannot undertake any responsibility for its accuracy, nor be held liable for any loss or damages arising out of or in connection with its use.